

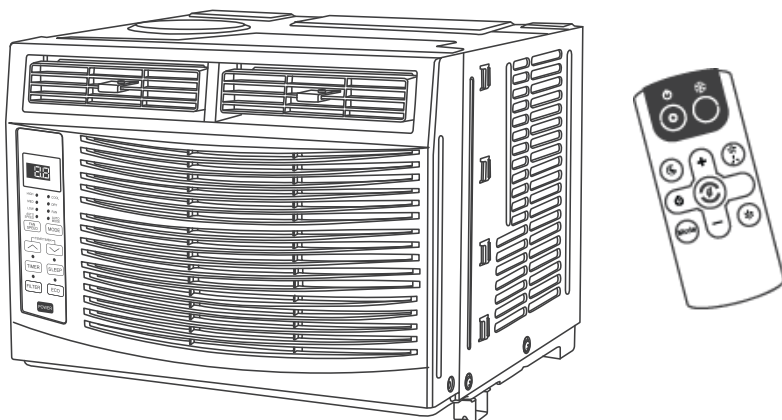

# Window Air Conditioner

## WAG-C & WAG-A Series



### USER MANUAL

#### For models:

WAG-C05KECO111E

WAG-A06KECO110E

Thank you for purchasing this Window Air Conditioner. Before operating this unit, please read these instructions completely and keep the manual ready for further reference.

---

# CONTENTS

■ Important Safety Instructions .....	01
■ Electrical Requirements .....	03
■ Packing List .....	05
■ Installation & Assembly Instructions .....	06
■ Using Your Air Conditioner .....	14
■ Care and Cleaning .....	18
■ Troubleshooting .....	19

---

## Important Safety Instructions

Before installing and using your air conditioner, please read this owner's manual carefully. Store this manual in a safe place for future reference. Your safety and the safety of others is very important to us. Please pay attention to all safety messages outlined in this user manual.

### **Warning**

To reduce the risk of fire, electrical shock or injury when using your air conditioner, follow the basic precautions below:

- Plug into a grounded 3 prong outlet.
- Do not remove the ground prong.
- Do not use a plug adapter.
- Do not use an extension cord.
- Unplug the air conditioner before servicing.
- Use two or more people to move and install the air conditioner.



This is a safety alert symbol. This symbol alerts you to potential hazards that can harm you or others or even cause death. All safety messages will directly follow the safety alert symbol and/or the words "DANGER" or "WARNING".

### **Danger**

Failure to immediately follow these instructions may cause serious injury or even death.

### **Warning**

All Safety messages alert you of potential hazards, how to reduce the chance of injury, and what can happen if instructions are not followed correctly.

---

## Introduction to Refrigerants R32

The refrigerants used for air conditioners are environmentally friendly hydrocarbons R32. This kind of erant is combustibile and odorless. Moreover, it can burn and explode under certain condition. However, there will be no risk of burning and explosion if you comply with the following table to install your air conditioner in a room with an appropriate area and use it correctly.

Compared with ordinary refrigerants, Refrigerant R32 is environmentally friendly and do not destroy the ozone sphere and that its value of greenhouse effect is also very low.

### **Warning**

- Please read the manual before installation, using, maintenance.
- Do not use means to accelerate the defrosting process or to clean, other than those recommended by the manufacturer.
- Do not pierce or burn the appliance.
- The appliance shall be stored in a room without continuously operating sources (for example: open flames, an operating ignition gas appliance or an operating electric heater.)
- Please contact the nearest after-sale service center when maintenance is necessary. At the time of maintenance, the maintenance personnel must strictly comply with the Operation Manual provided by the corresponding manufacturer and any non-professional is prohibited to maintain the air conditioner.
- The handling, installation, storage, servicing and disposal must comply with the provisions of gas-related national laws and regulations, and also national wiring regulation.
- It is necessary to clear away the refrigerant in the system when maintaining or scrapping an air conditioner. Be aware that refrigerants may not contain an odour.

This appliance is not intended for use by persons (including children) with reduced physical, sensory or mental capabilities, or supervision or instruction concerning use of the appliance by a person responsible for their safety.

Children should be supervised to ensure that they do not play with the appliance.

Unit operation limits: Outdoor side 61~110°F, 80%RH, indoor side 61~90°F, 80%RH.



---

## ■ ■ Electrical Requirements

### Warning

#### Electrical Shock

- Hazard Plug into a grounded 3 prong outlet.
- Do not remove the ground prong.
- Do not use an adapter.
- Do not use an extension cord.
- Failure to follow these instructions can result in death, fire, or electrical shock.

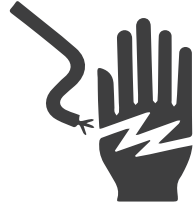

The electrical ratings for your air conditioner are listed on the model and serial number label located on the front left side of the unit (when facing the front). Specific electrical requirements are listed in the chart below. Follow the requirements below for the type of plug on the power supply cord.

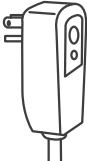
Wiring Requirements	Power Supply Cord
<ul style="list-style-type: none"><li>● 115 volt (103min. —127max)</li><li>● 0-8 amps</li><li>● 10-amp time-delay fuse or circuit breaker</li><li>● Use on single outlet circuit only</li></ul>	

#### Recommended Ground Method

For your personal safety, this air conditioner must be grounded. This air conditioner is equipped with a 3 prong power supply cord with a grounded plug. To minimize the possibility of electrical shock, the cord must be plugged into a 3 prong outlet and grounded in accordance with all local codes and ordinances. If a 3 prong outlet is not available, it is the customer's responsibility to have a properly grounded 3 prong outlet installed by a qualified electrician.

#### It is the customer's responsibility:

- To contact a qualified electrician.
- To assure that the electrical installation is adequate and in conformance with the National Electrical Code, ANSI/NFPA 70-latest edition, and all local codes and ordinances.

---

## LCDI Power Cord and Plug

This air conditioner is equipped with an LCDI (Leakage Current Detection and Interruption) power cord and plug as required by US National Electric Code 440.65. This cord consists of a length of shielded flexible cord with no termination on the load side and a LCDI attachment plug on the line side.

The LCDI power cord and plug will remove the supply source via electrical disconnect (circuit trip) if the nominal current leakage between the cord shield and either load conductor exceeds a predetermined value. The cord will remain deenergized until the device has been manually reset. This is intended to reduce the risk of a fire in the power cord or combustible materials nearby. The cord shields are not grounded and they must be considered a shock hazards if exposed. The cord shield must not be connected to ground or to any exposed metal.

The test and reset buttons on the LCDI Plug are used to check if the plug is functioning properly.

### To test the plug:

- Plug power cord into a wall outlet.
- Press the TEST Button, the circuit should trip and cut all power to the air conditioner.
- Press the RESET button for use.

If a test is performed and the indicator light remains ON, the current leakage has been detected. Do not use the air conditioner or attempt to reset the LCDI Plug. Contact Customer Service for troubleshooting recommendations.

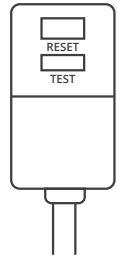

# Packing List

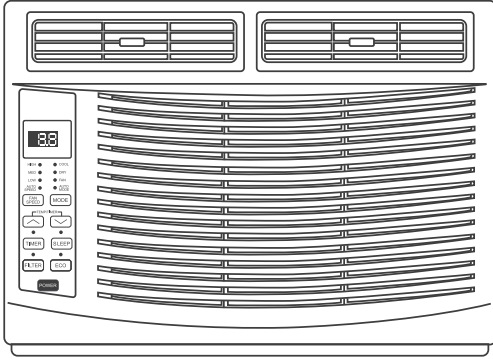

Window Air Conditioner \*1

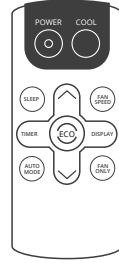

Remote Control \*1

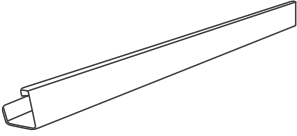

Top Rail (With sponge) \*1

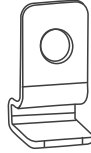

Lock Frame \*2

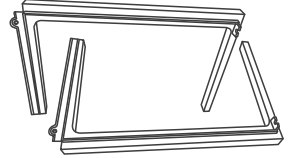

Filler Panels \*2  
(With "Left" & "Right" remark on the front face)



Sash Lock  
(Two holes) \*1

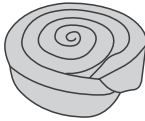

Window Sash Seal  
(Sponge) \*1

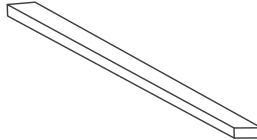

Foam Top Window  
Gasket \*1  
(Thin sponge for back-up using)



Insulation strip  
(Sponge) \*2  
(Only for E-star model)



3/8"Screws \*4



1/2"Screws \*3

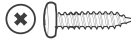

3/4"Screws \*4

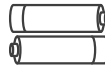

Remote Control  
Battery \*2

## Installation & Assembly Instructions

Some assembly is required for your new air conditioner. Please read and follow these instructions carefully.

- This air conditioner is designed to be installed in a standard double-hung window with a window width between 23" and 34" (584mm-863 mm).
- The air conditioner can be installed without the accordion panels to fit in a narrow window opening. See the window dimensions.
- The Lower Sash (the lower part of the window that moves up and down) must allow for 14.5" of vertical clearance when open. (See Fig.1).
- All supporting parts must be secured to firm wood, masonry, or metal.
- The electrical outlet must be within reach of the power cord.
- The air conditioner should be tilted about 3° for better drainage of condensate and rainwater.

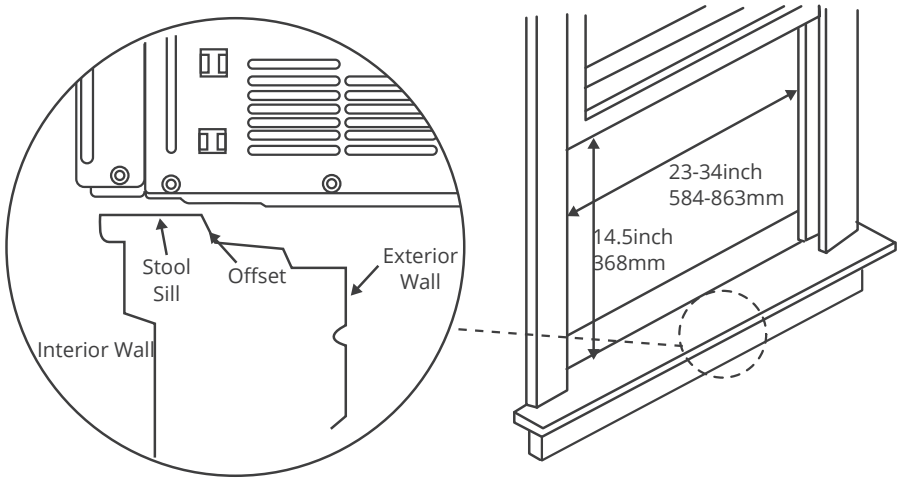

Fig.1

### NOTE:

- Save the product packaging and installation instructions for future reference.
- Store the air conditioner in the product box when not in use for an extended period of time.



# Top Rail Assembly

The top rail must be assembled prior to installing the air conditioner in the window.

**Tools Needed:** Phillips Head Screw Driver

## Attaching the Top Rail to the Air Conditioner

- Remove the air conditioner from the box and place on a hard and flat surface.
- Remove top rail from the top of the packaging material as shown in Fig.A.
- Align the hole in the top rail with those in the top of the unit as shown in Fig.B.
- Secure the top rail to the unit with the 3/8" screws as shown in Fig.C.

### **Caution**

When handling the unit, be careful to avoid cuts from the sharp metal edges and aluminum fins on the front and rear coils.

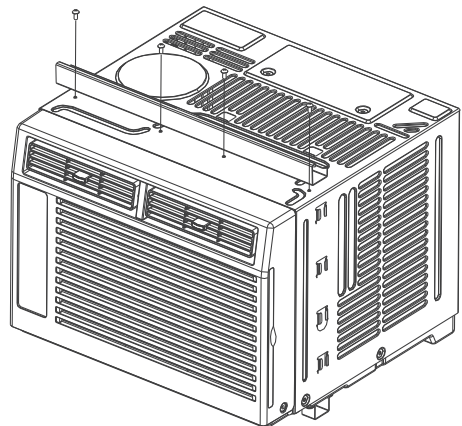
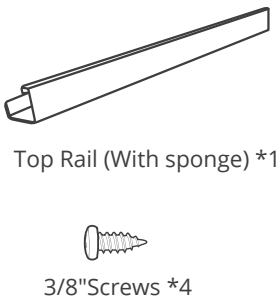
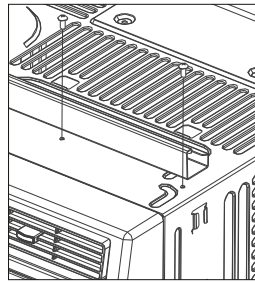
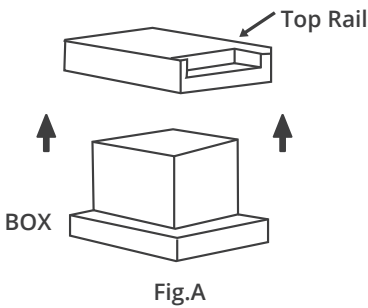

**NOTE:** For safety reasons, all 4 screws must be used to attach the top rail.

---

## Accordion Panel Installation

Now that you have installed the top rail, you can now install the accordion panels on each side.

- Place the air conditioner on a hard flat surface.
- Locate the accordion panels in the box.
- Gently pull the free end of the accordion panel (See Fig.2). Do this for both panels.
- Slide the free end of the accordion panel into the side panel of the air conditioner (See Fig.3). Do this for each side.

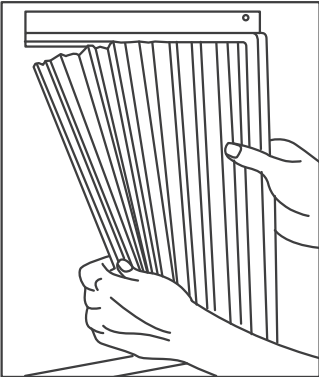

Fig.2

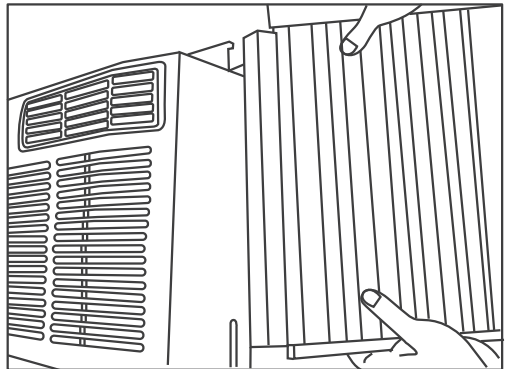

Fig.3

- Once the accordion panels are slid into place adjust the top and bottom rails of the accordion panels into the top and bottom rails of the air conditioner (See Fig.4).

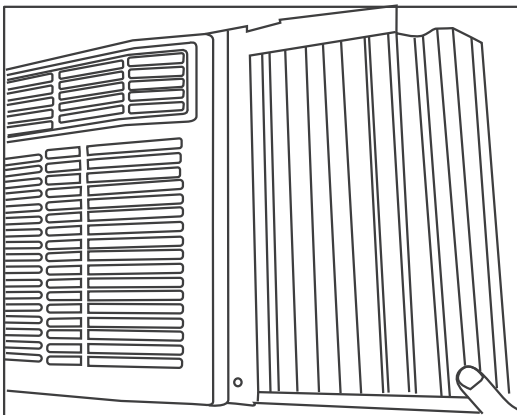

Fig.4

## Storm Window Requirements

A storm window frame will not allow the air conditioner to tilt properly which in turn will keep it from draining properly.

To adjust for this, attach a board or piece of wood to the sill. The board or wood piece should have a depth of at least 1-1/2". Make sure the board or piece of wood is approximately 1/2" higher than the storm window frame. This will allow the air conditioner to tilt enough for proper drainage. (See Fig.5).

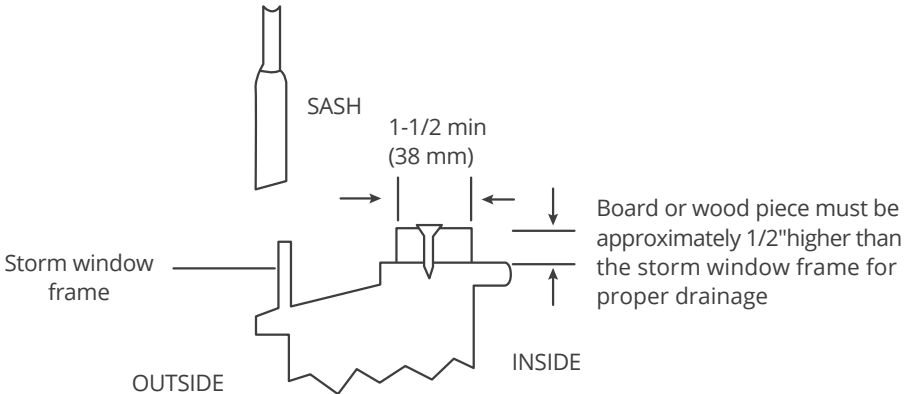

Fig.5

## Placing the Unit Inside a Window

- Place the air conditioner on the sill with the bottom mounting rail against its back edge. Center the air conditioner and close the window securely behind the top mounting rail. The air conditioner should be 3° slightly tilted to the outside area. Use a level, about a 1/3 bubble will be the correct case slant to the outside. (See FIG.6 & FIG.7) (It is suggested to keep a downward angle to let accumulated rain water drain out from the back side of the unit bottom.)

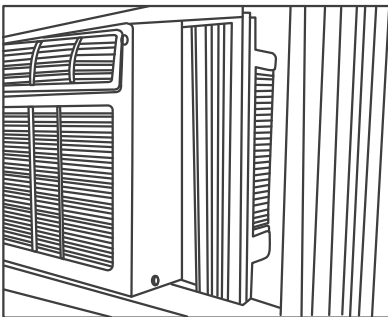

Fig.6

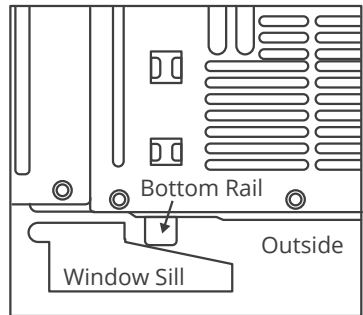

Fig.7

- Once the air conditioner is placed, extend both the left and right accordion panels to the width of the window.

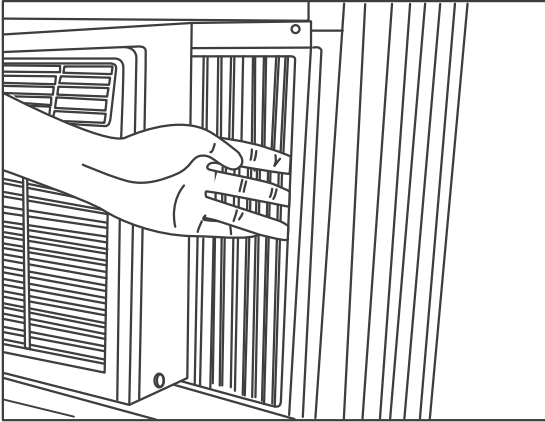

Fig.8

## Frame Lock, Sash Lock, and Foam Seal Installation

### Mounting Hardware

#### Tools Needed:

- Phillips Head Screw Driver
- Drill (if pilot holes are needed)

- Place the frame lock between the extended accordion panels and the window sill as show in Fig.9. Screw a 3/4" (19mm) locking screw through the frame lock anc into the window sill. (Fig.10)

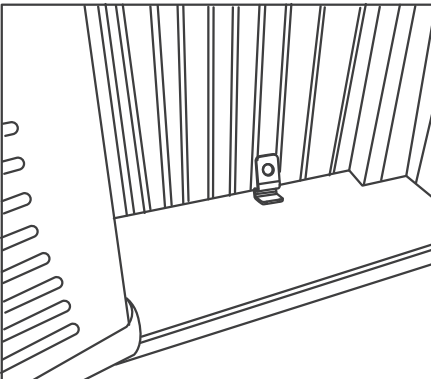

Fig.9

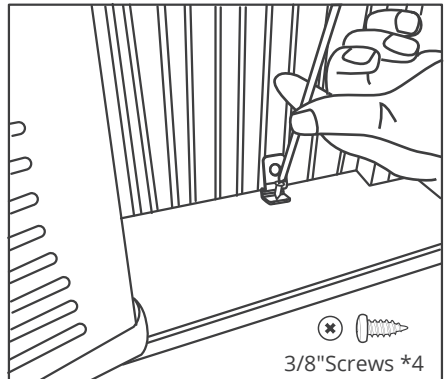

Fig.10

- 
- Drive 1/2" screws into the top of the accordion panel frame and the top rail to securely attach the window air conditioner to the lower sash. (See Fig.11 Fig.12)

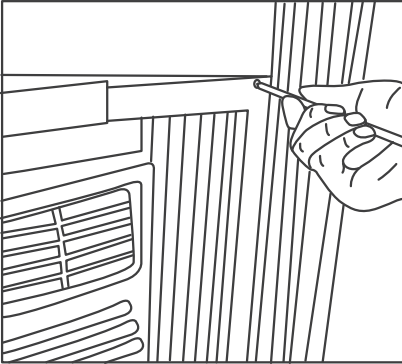

Fig.11

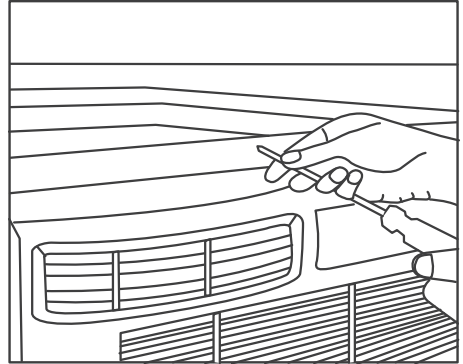

Fig.12

- To secure the lower sash into place, use the sash lock and a 3/4" screw as shown below. (See Fig.13)
- For added insulation, cut the supplied insulation foam to the width of the window. Insert the foam between the window sashes to prevent air and objects from getting into the room. (See Fig.14)

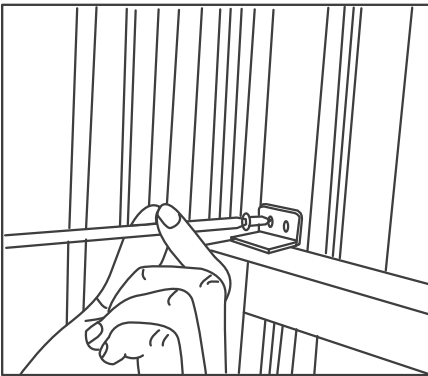

Fig.13

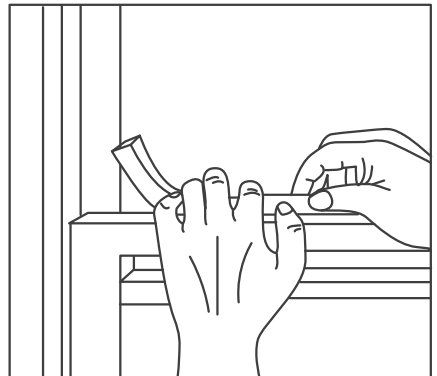

Fig.14

---

## Removing the Air Conditioner from the Window

- Turn the air conditioner off and unplug the power cord.
- Remove the sash seal from between windows, and unscrew sash lock.
- Remove the screws installed through the frame and frame lock.
- Close (slide) the side panels into frame.
- Keeping a firm grip on air conditioner, raise the sash and carefully "rock" air conditioner backward to drain any condensate water in base of unit. Be careful not to spill any remaining water while lifting unit from window.
- Store parts with the air conditioner in the box.

## Introduction to Refrigerants R32

- Before installing the appliance, you must read the manual carefully to get the safety information and notes.
- When filling the combustible refrigerant, any of your rude operations may cause serious injury or injuries to human body or bodies and object or objects.
- A leak test must be done after the installation is completed.
- It is a must to do the safety inspection before maintaining or repairing an air conditioner using combustible refrigerant in order to ensure that the fire risk is reduced to minimum.
- It is necessary to operate the machine under a controlled procedure in order to ensure that any risk arising from the combustible gas or vapor during the operation is reduced to minimum.
- Requirements for the total weight of filled refrigerant and the area of a room to be equipped with an air conditioner.



### 1. Site Safety



Open Flames Prohibited



Ventilation Necessary

### 2. Operation Safety



Mind Static Electricity



Must Wear Protective Clothing  
and anti-static gloves



Don't use mobile phone

---

### 3. Installation Safety



- 1) Refrigerant Leak Detector
- 2) Appropriate Installation Location
- 3) The left picture is the schematic diagram of a refrigerant leak detector

#### Please note that:

- The installation site should be in a well-ventilated condition.
- The sites for installing and maintaining an air conditioner using Refrigerant R32 should be free from open fire or welding, smoking, drying oven or any other heat source higher than 548°C which easily produces open fire.
- When installing an air conditioner, it is necessary to take appropriate anti-static measures such as wear anti-static clothing and/or gloves.
- It is necessary to choose the site convenient for installation or maintenance wherein the air inlets and outlets of the indoor and outdoor units should be not surrounded by obstacles or close to any heat source or combustible and/or explosive environment.
- If the indoor unit suffers refrigerant leak during the installation, all the personnel should go out till the refrigerant leaks completely for 15 minutes. If the product is damaged, it is a must to carry such damaged product back to the maintenance station and it is prohibited to weld the refrigerant pipe or conduct other operations on the user's site.
- It is necessary to choose the place where the inlet and outlet air of the indoor unit is even.
- It is necessary to avoid the places where there are other electrical products, power switch plugs and sockets, kitchen cabinet, bed, sofa and other valuables right under the lines on two sides of the indoor unit, and also prevent mechanical damage from occurring.

---

# Using Your Air Conditioner

## Normal Operating Sounds

- You may hear a pinging noise caused by water hitting the condenser, on rainy days, or when the humidity is high. This design feature helps remove moisture and improve efficiency.
- You may hear the thermostat click when the compressor cycles on and off.
- Water will collect in the base pan during rain or days of high humidity. The water may overflow and drip from the outside part of the unit.
- The fan may run even when the compressor is not on.

## Manual Control Panel

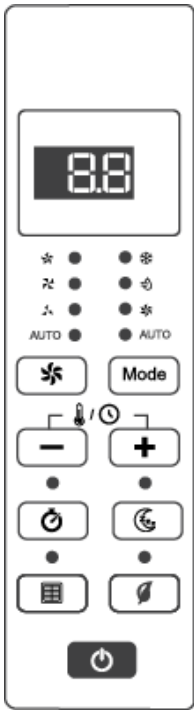

### 1. Digital Display:

When the timer is not in use, the operation mode and the set temperature will be displayed. Time will be displayed under the timer setting.

### 2. Mode Button:

Press the mode button to cycle through the various modes: Cool, Dry, Fan and Auto.

**Cool Mode:** The cooling function allows the air conditioner to cool the room and at the same time reduces humidity. Press the MODE button to activate the cooling function. To optimize this function adjust the temperature by pressing the up and down arrows and the speed by pressing the Fan Speed button.

**Dry Mode:** This function reduces the humidity of the air to make the room more comfortable. Press the MODE button to set the DRY mode. An automatic function of alternating cooling cycles and air fan is activated.

**Fan Mode:** This function only works when the air conditioner is vented. Press the MODE button to set the FAN mode. With pressing the FAN SPEED button, the speed changes in the following sequence: HIGH, MED, LOW in FAN mode.

**Auto Mode:** In AUTO mode the unit automatically chooses the mode of operation (COOL, FAN). In this mode the temperature is set automatically according to the room temperature (Room temperature is determined by the temperature sensor located in the indoor unit).



---

### 3. and Button:

Use these buttons on the control panel and remote to increase or decrease the Set Temperature or Timer. Long press the down button 3s can override the dr mode.

Temperature range: 61°F~88°F or 16°C~31°C.

### 4. Sleep Button:

Press the SLEEP button, all of the display lights will turn off after a while, but the Sleep light is always on. In SLEEP mode, the air conditioner will automatically adjust the temperature and fan speed to make the room more comfortable during the night. The set temperature will automatically raise or decrease based on the room temperature and the duration of sleep.

### 5. Eco Button:

When the unit is in ECO mode, the light will turn on. In ECO mode, the unit will turn off once the room is cooled to the user-set temperature.

The unit will turn back on when the room temperature rises above the user-set temperature. Before the compressor starts, the fan motor will run for a while, then it will stop for a while, and will repeat to provide a much more comfortable feeling and save energy.

### 6. Power Button:



Turn the air conditioner on and off.





### 7. Filter Button:



When the Filter Check light is off, it is not necessary to press the Filter Check button. When the Filter Check light is on, you can turn off the light by pressing the Filter Check button. After the fan motor works for 500 total hours, the Filter Check light will turn on to remind the user to clean the filter.

### 8. Timer Button:

Use these buttons on the control panel and remote to set the Timer.

**Timer Off:** The timed stop is programmed by pressing TIMER button. Set the rest time by pressing the button  or  until the rest time displayed is to your demand then press TIMER button again.

**Timer On:** When the unit is off, press TIMER button at the first time, set the temperature with pressing the button  or . Press TIMER button at the second time, set the rest time with pressing the button  or . Press TIMER button at the third time, confirm the setting, then it will show on the display.

**Note:** It can be set to automatically turn off or on in 0.5-24 hours. Each press of the   buttons will increase or decrease the timer. The Timer can be set in 0.5 hours increment below 10 hours and 1 hour increment for 10 hours or above. The SET light will turn on while setting. To cancel the setted function, press the TIMER button again.

---

## 9. Fan Speed Button:

Press the FAN SPEED button to select the fan speed. In COOL MODE you can choose the following settings: HIGH, MED, LOW, or AUTO. In FAN MODE you can choose from HIGH, MED, LOW.

## 10. Directional Louvers:

Use the horizontal wheels to control horizontal airflow and the air deflectors to control vertical airflow.

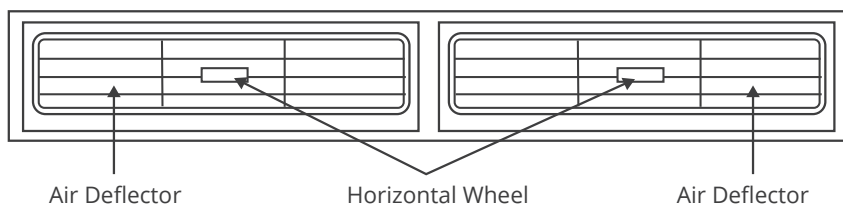

## REMOTE CONTROL

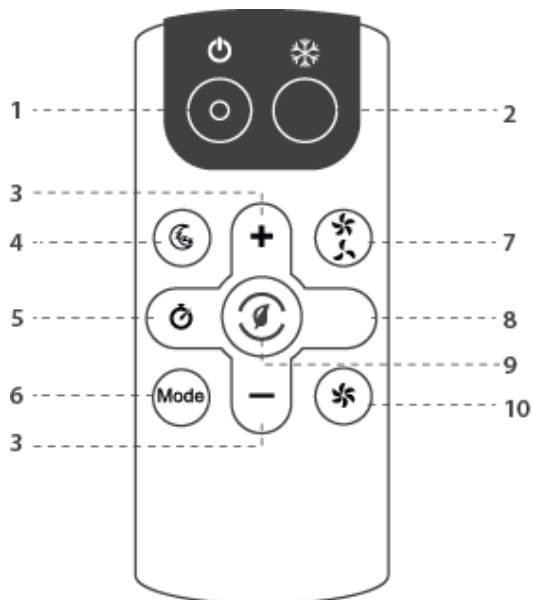

---

## 1. POWER

Turn the air conditioner on and off.

## 2. Cool

Press the COOL button to COOL mode.

## 3. and

Use these buttons on the control panel and remote to increase or decrease the Set Temperature or Timer.



**Temperature range:** 61°F~88°F or 16°C~31°C .





## 4. Sleep



Press the SLEEP button, all of the display lights will turn off after a while, but the Sleep light is always on. In SLEEP mode, the air conditioner will automatically adjust the temperature and fan speed to make the room more comfortable during the night. The set temperature will automatically raise or decrease based on the room temperature and the duration of sleep.

## 5. Timer

Use these buttons on the control panel and remote to set the Timer.

**Timer Off:** The timed stop is programmed by pressing TIMER button. Set the rest time by pressing the button  or  until the rest time displayed is to your demand then press TIMER button again.

**Timer On:** When the unit is off, press TIMER button at the first time, set the temperature with pressing the button  or . Press TIMER button at the second time, set the rest time with pressing the button  or . Press TIMER button at the third time, confirm the setting, then it will show on the display.

**Note:** It can be set to automatically turn off or on in 0.5-24 hours. Each press of the   buttons will increase or decrease the timer. The Timer can be set in 0.5 hours increment below 10 hours and 1 hour increment for 10 hours or above. The SET light will turn on while setting. To cancel the set function, press the TIMER button again.

## 6. Auto Mode

In AUTO mode the unit automatically chooses the mode of operation (COOL, or FAN). In this mode the temperature will be set automatically according to the room temperature (tested by the temperature sensor which is incorporated in the indoor unit.).

## 7. Fan Speed

Press the FAN SPEED button to choose the fan speed options. You can choose HIGH, MED, LOW or auto speed in COOL mode and choose HIGH, MED, LOW in FAN mode.

## 8. Display

To press the DISPLAY button, it can switch off/on all lights or LED display.

---

## 9. ECO

When the unit is in ECO mode, the light will turn on. In ECO mode, the unit will turn off once the room is cooled to the user set temperature. The unit will turn back on when the room temperature rises above the user set temperature. Before the compressor starts, the fan motor will run for a while, then it will stop for a while, and will repeat to provide a much more comfortable feeling and save energy.

## 10. Fan Only

Press the Fan Only button to FAN ONLY mode.

### Battery Size:

**AAA-NOTE:** Do not mix old and new batteries or different types of AAA batteries.

# ■ ■ Care and Cleaning

## Air Filter Cleaning

The air filter should be checked at least once every month to see if it needs cleaning. Trapped particles and dust can build up in the filter and may decrease airflow as well as cause the cooling coils to accumulate frost.

### To clean the air filter:

- Take off the power plug, then remove the filter by sliding it out from the front right side of the air conditioner. (See Fig .15)
- Wash the filter using liquid dish soap and warm water. Rinse the filter thoroughly. Gently shake the filter to remove excess water.
- Let the filter dry completely before placing it into the air conditioner.
- If you do not wish to wash the filter, you may vacuum the filter to remove the dust and other particles.

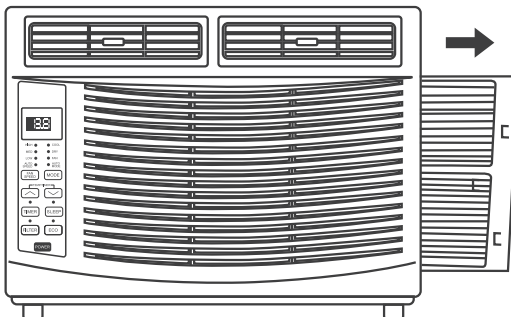

Fig.15

---

## Cabinet Cleaning

To clean the air conditioner cabinet:

- Unplug the air conditioner to prevent shock or a fire hazard. The cabinet and front panel of the air conditioner may be dusted with an oilfree cloth or washed with a cloth dampened in a solution of warm water and mild liquid soap. Rinse thoroughly with a damp cloth and wipe dry.
- Never use harsh cleaners, wax or polish on the cabinet front.
- Be sure to wring excess water from the cloth before wiping around the controls. Excess water in or around the controls may cause damage to the air conditioner.

## Winter Storage

To store the air conditioner when it is not in use for an extended period of time, remove it carefully from the window according to the installation instructions and cover it with plastic or place it in the original box.

## ■ ■ ■ Troubleshooting

Problem	Possible Causes	Solutions
The Air Conditioner will not start	The air conditioner is unplugged	Make sure the air conditioner plug is pushed completely into the outlet.
	The fuse is blown/circuit breaker is tripped	Check the house fuse/circuit breaker box and replace the fuse or reset the breaker.
	Power failure	<ul style="list-style-type: none"><li>● The unit will automatically re-start when power is restored.</li><li>● There is a protective time delay (approx.3 minutes) to prevent tripping of the compressor overload. For this reason, the unit may not start normal cooling for 3 minutes after it is turned back on.</li></ul>

Problem	Possible Causes	Solutions
The Air Conditioner will not start	The current interrupter device is tripped	<ul style="list-style-type: none"> <li>• Press the RESET button located on the power cord plug.</li> <li>• If the RESET button will not stay engaged, discontinue use of the air conditioner and contact a qualified service technician.</li> </ul>
The Air Conditioner does not cool as it should	Airflow is restricted	Make sure there are no curtains, blinds, or furniture blocking the front of the air conditioner.
	The temperature control may not be set correctly	Lower the set thermostat temperature.
	The air filter is dirty	Clean the filter. See the Cleaning and Care Section of the manual.
	The room may be too warm	Please allow time for the room to cool down after turning on the air conditioner.
	Cold air is escaping	Check for open furnace registers and cold air returns.
	The cooling coils are frozen	See "Air Conditioner Freezing Up" below.
The Air Conditioner is freezing up	Ice blocks the air flow and stops the air conditioner from cooling the room	Set the MODE dial to HIGH FAN or HIGH COOL and set the thermostat to a higher temperature.
The Remote Control is not working	<ul style="list-style-type: none"> <li>• The batteries are inserted incorrectly</li> <li>• The batteries may be dead</li> </ul>	<ul style="list-style-type: none"> <li>• Check the position of the batteries.</li> <li>• Replace the batteries.</li> </ul>
Water is dripping outside	Hot and humid weather	This is normal.

Problem	Possible Causes	Solutions
Water is dripping inside the room	The air conditioner is not correctly tilted outside	For proper water drainage, make sure the air conditioner is slightly tilted downward from the front of the unit to the rear.
Water collects in the base pan	Moisture removed from the air is draining into the base pan	This is normal for a short period in areas with low humidity and normal for a longer period in areas with high humidity.
Display dr and unit without control	The air conditioner is under demand response, only turn ON/OFF can be activated, and the set temperature may raise, and the compressor may stop	It is the demand response condition, you can wait for the Delay time or override it by long press down button for 3s on the control panel.